

1" X 1" X 0.125" STEEL TUBING - 32' REQD		
ID	QTY	LENGTH
A	2	66" LONG TO LONG
B	2	24" LONG TO LONG
C	2	23" LONG TO SQUARE
D	2	40" SQUARE TO SQUARE
E	1	22" SQUARE TO SQUARE
F	1	30.25" SQUARE TO SQUARE
G	1	26.25" SQUARE TO SQUARE

1" X 1" X 0.083" STEEL TUBING - 36' REQD		
ID	QTY	LENGTH
1	5	40" SQUARE TO SQUARE
2	2	32.25" LONG TO LONG
3	4	14" LONG TO LONG
4	2	13" LONG TO SQUARE
5	2	12" LONG TO LONG
6	2	7" SQUARE TO SQUARE
7	1	8" SQUARE TO SQUARE

1" X 1" X 0.125" STRUCTURAL ANGLE - 33' REQD		
ID	QTY	LENGTH
8	4	40" LONG TO LONG
9	2	22" LONG TO LONG
10	2	23" LONG TO LONG
11	2	14" LONG TO LONG

ASSEMBLY NOTES:

- ALL MITERS ARE 45°
- WELD A,B,C,2,3,4,5 TOGETHER TO FORM END FRAMES
- SQUARE AND STRAIGHTEN AS NECESSARY
- FRAME SQUARENESS IS IMPORTANT FOR DRAWER INSTALLATION
- LOCATION AND QUANTITY OF SHELVES IN LOWER CABINET IS OPTIONAL
- LOCATION AND QUANTITY OF DRAWERS IS OPTIONAL
- ELEVATION OF WORKSURFACE = 36" AFTER ADDITION OF CASTERS

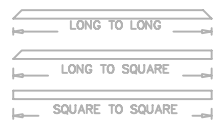

HIDDEN LINES REMOVED FOR CLARITY



THIS DRAWING AS WELL AS ANY INTELLECT WHICH MAY BE REPRESENTED IS THE SOLE PROPERTY OF MXTRAS AND SHALL NOT BE COPIED OR UTILIZED FOR COMMERCIAL GAIN WITHOUT PERMISSION		DO NOT SCALE
COMPONENT DESIGNATION V2 WORKSTATION WELDMENT		ENGLISH
REV. #		
BY:		
DATE:		
ORIGINAL BY: NEIL, S.	MATERIAL: ASSEMBLY - SEE LIST	
CHECKED BY: SN	DATE OF ORIGINAL: 11/05	DRAWING NO.: 11072005.02
APPROVED BY: SN	SCALE: *.*	REVISION: 1

#	REVISION DESCRIPTION

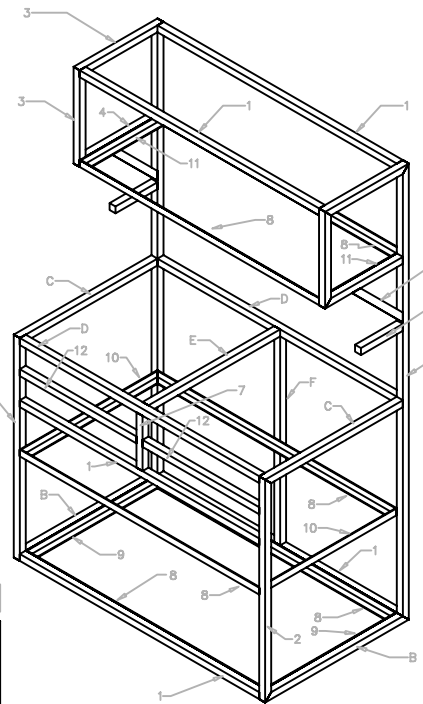
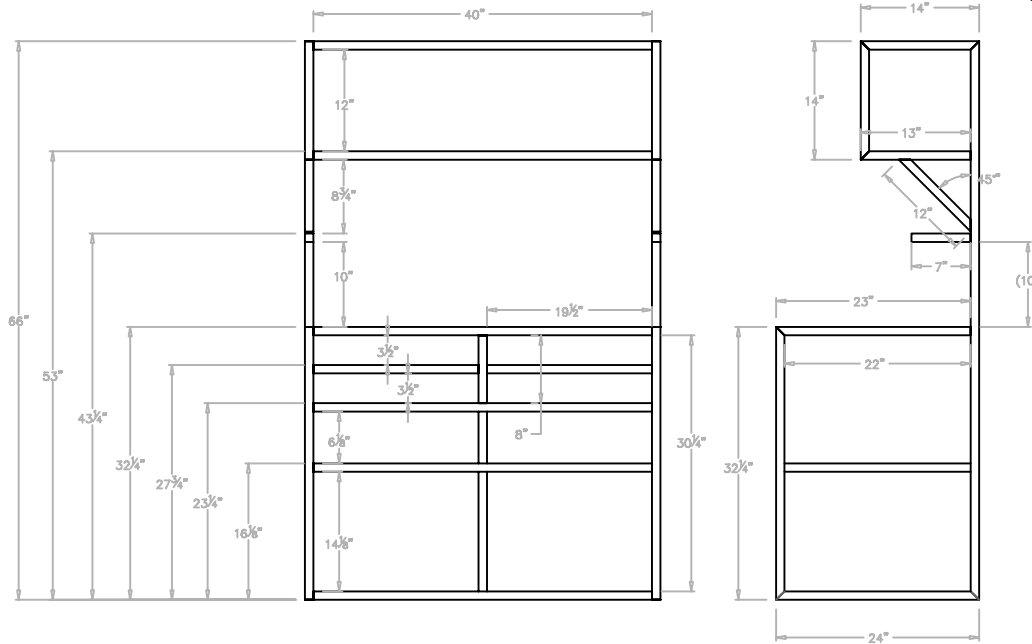
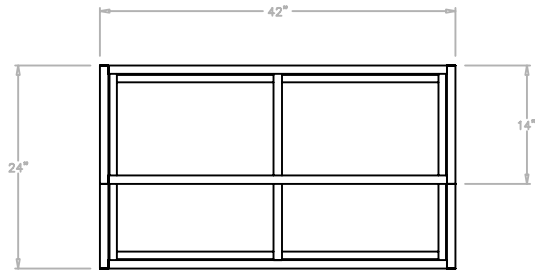

1" X 1" X 0.125" STEEL TUBING - 30' REQD		
ID	QTY	LENGTH
A	2	66" LONG TO LONG
B	2	24" LONG TO LONG
C	2	23" LONG TO SQUARE
D	2	40" SQUARE TO SQUARE
E	1	22" SQUARE TO SQUARE
F	1	30.25" SQUARE TO SQUARE

1" X 1" X 0.083" STEEL TUBING - 33' REQD		
ID	QTY	LENGTH
1	5	40" SQUARE TO SQUARE
2	2	32.25" LONG TO LONG
3	4	14" LONG TO LONG
4	2	13" LONG TO SQUARE
5	2	12" LONG TO LONG
6	2	7" SQUARE TO SQUARE
7	1	8" SQUARE TO SQUARE

1" X 1" X 0.125" STRUCTURAL ANGLE - 33' REQD		
ID	QTY	LENGTH
8	6	40" LONG TO LONG
9	2	22" LONG TO LONG
10	2	23" LONG TO LONG
11	2	14" LONG TO LONG
12	2	19.5" SQUARE TO SQUARE

ASSEMBLY NOTES:

- ALL MITERS ARE 45°
- WELD A,B,C,2,3,4,5 TOGETHER TO FORM END FRAMES SQUARE AND STRAIGHTEN AS NECESSARY
- FRAME SQUARENESS IS IMPORTANT FOR DRAWER INSTALLATION
- LOCATION AND QUANTITY OF SHELVES IN LOWER CABINET IS OPTIONAL
- ELEVATION OF WORKSURFACE = 36" AFTER ADDITION OF CASTERS

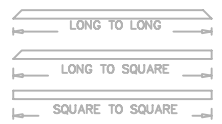

HIDDEN LINES REMOVED FOR CLARITY



THIS DRAWING AS WELL AS ANY INTELCT WHICH MAY BE REPRESENTED IS THE SOLE PROPERTY OF MXTRAS AND SHALL NOT BE COPIED OR UTILIZED FOR COMMERCIAL GAIN WITHOUT PERMISSION		DO NOT SCALE
COMPONENT DESIGNATION V1 WORKSTATION WELDMENT		ENGLISH
REV. # 1	BY: SN	
DATE: 11/7/05		
ORIGINAL BY: NEIL, S.	MATERIAL: ASSEMBLY - SEE LIST	
CHECKED BY: SN	DATE OF ORIGINAL: 11/05	DRAWING NO.: 11072005.01
APPROVED BY: SN	SCALE: *.*	REVISION: 1

#	REVISION DESCRIPTION
1	TOP, FRONT EDGE AND BOTTOM DRAWER LEDGE CHANGED FROM TUBING TO ANGLE

WORKSTATIONS

SHELF PANELS, NON-APPEARANCE  
THESE PANELS MAY BE CUT ON A PANEL SAW

APPEARANCE PANELS  
THESE PANELS MAY BE CUT ON A PANEL SAW

ROUTED ACM PANELS  
THIS DATA IS ALREADY COMPENSATED FOR USING AN 1/8" CUTTER  
 BEND REDUCTIONS AND GAINS ARE CONFIGURED FOR 3MM ACM MATERIAL  
 DIMENSIONS GIVEN ARE OUTSIDE, FOLDED DIMENSIONS IN INCHES

TOP CAB. TOP  
 42 X 14  
 1 PC NEEDED

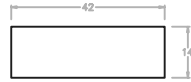

LOWER SIDE  
 31.75 X 23.5  
 1 PC NEEDED

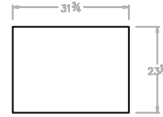

STANDARD DRAWER  
 18.5 WIDE  
 23.5 LONG  
 3.0 DEEP

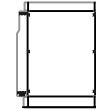

TOP SHELF  
 39.625 X 13.875  
 1 PC NEEDED



UPPER SIDE  
 13.5 X 13.5  
 2 PC NEEDED



PULL OUT  
 18.5 WIDE  
 23.5 LONG  
 3.0 DEEP

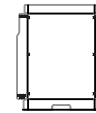

BOTTOM SHELF  
 39.625 X 21.625  
 1 PC NEEDED



UPPER BACK  
 41.5 X 13.5  
 1 PC NEEDED

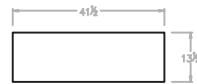

DEEP, BOTTOM DRAWER  
 18.5 WIDE  
 23.5 LONG  
 4.25 DEEP

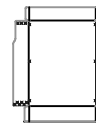

BOTTOM, MID SHELF  
 39.625 X 22.625  
 QTY VARIES, MIN 1X



LOWER BACK  
 41.5 X 31.75  
 1 PC NEEDED

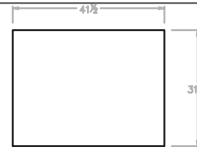

WIDE, TOP DRAWER  
 39.0 WIDE  
 23.5 LONG  
 3.0 DEEP

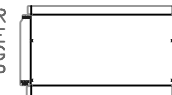

TOP DOORS  
 20.5 X 13.5  
 2 PC NEEDED

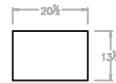

EXTERIOR SHELF  
 8.0 WIDE  
 42.25 LONG

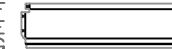

BOTTOM DOORS  
 31.75 X 20.5  
 2 PC NEEDED



STANDARD FACE  
 19.5 X 3.5



WIDE FACE  
 40.0 X 3.5



WORK SURFACE  
 43 X 25  
 1 PC NEEDED

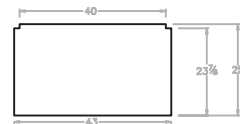

PULL OUT FACE  
 19.5 X 3.5



BOTTOM DRAWER FACE  
 19.5 X 5.438

